

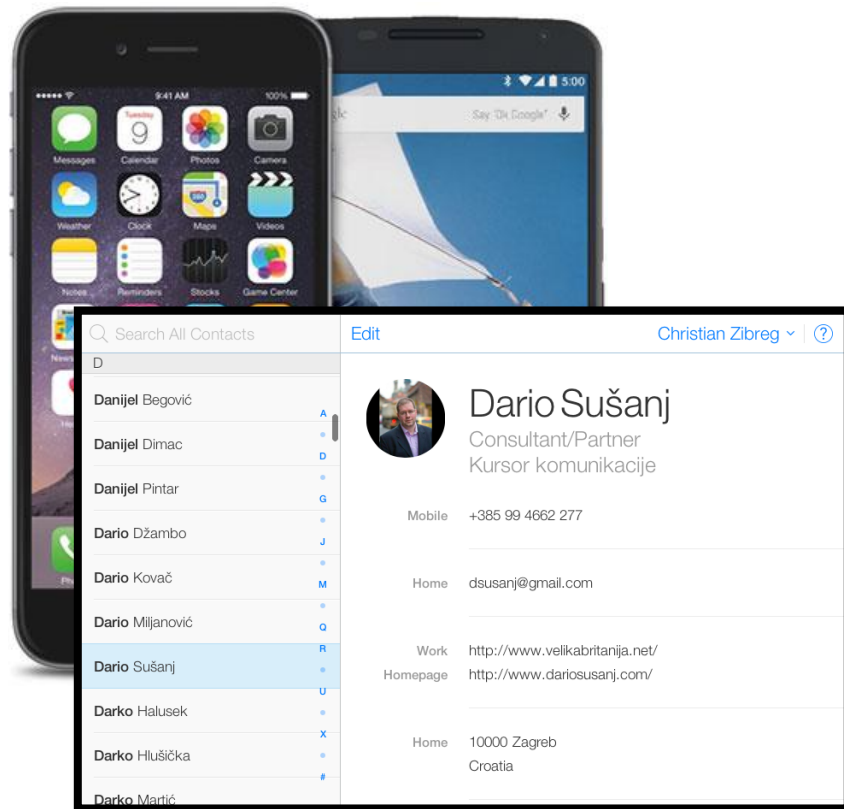

# Connectivity from A to Z – Roadmap for PI Connectors and PI Interfaces

Presented by **Chris Coen, Product Manager**  
**Zdenek Ryska, Senior Software Developer**

# Technology

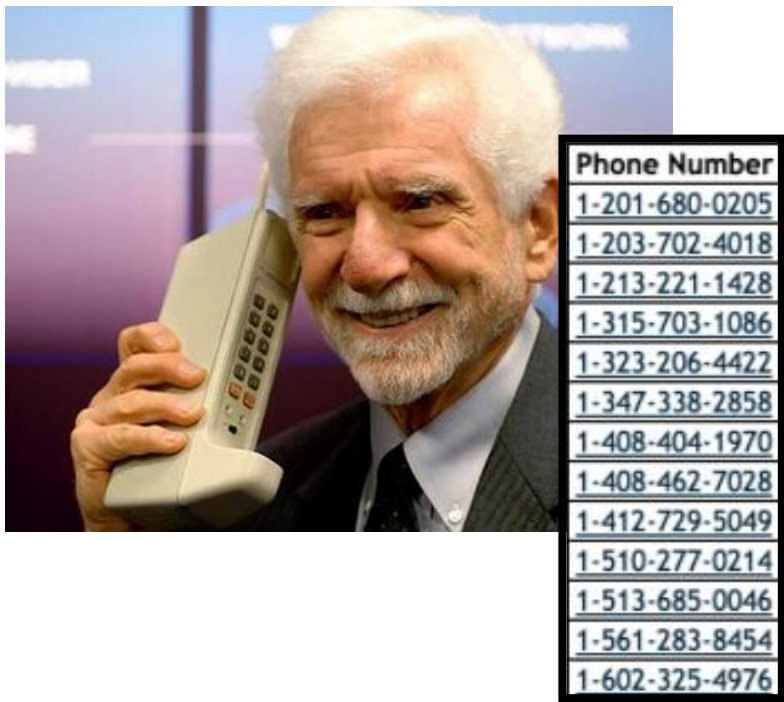

# Control systems evolve

Register	Value
1	27
2	Off
3	53.89
4	3.2
...	...
2501	Running
2502	45.8
2503	1

- Chemical Plant
  - Line 1
    - Heat Exchangers
      - Heat Exchanger 1001
        - Area
          - Cold Side Inlet Temperature
          - Cold Side Outlet Temperature
          - Hot Side Inlet Temperature
          - Hot Side Outlet Temperature
          - Manufacturer
        - Heat Exchanger 1002
      - Pumps
        - SF Pump 001
        - SF Pump 002
      - Tanks
    - Line 2

# Patterns of Data Collection

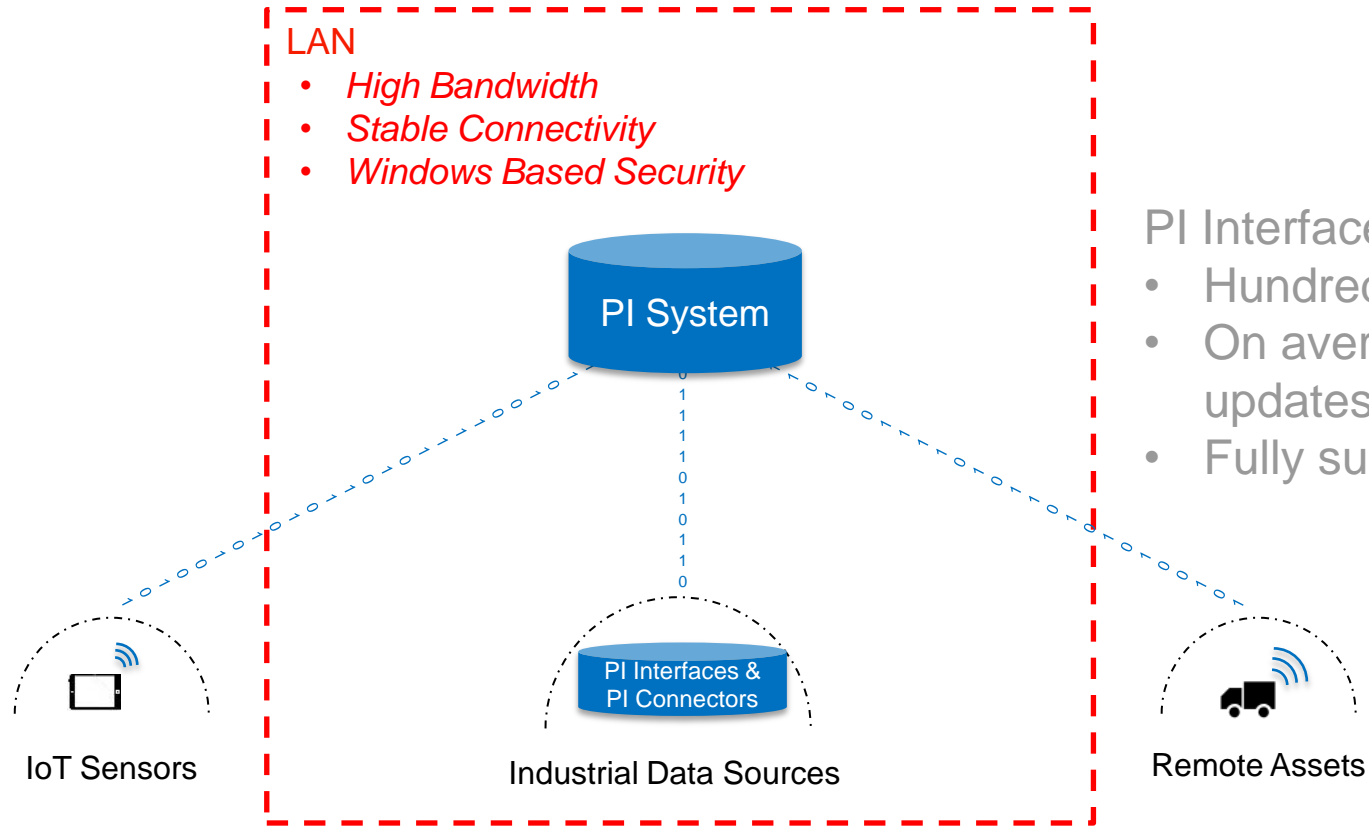

# PI Connectors help you to be Strategic



## Streamlined Configuration

Auto create PI Points and AF reference model with rules-based data selection.

## Auto discover data, now and later

PI Connectors monitor the source so you don't have to.

## Unified Admin Experience

A one-stop shop to manage data collection across your sources.

## Secure & Flexible Architectures

Send data securely across diverse networks to multiple destinations.

# Available today



PI Connector	Market
BACnet	Facilities
CygNet	Upstream Oil and Gas
DC Systems RTscada	T&D
EtherNet/IP	High-speed PLC data
HART-IP	Many. Wireless sensors
IEC 60870-5-104	T&D Substations
IPMI	Datacenters
NOV WITSML	Upstream, drilling
OPC UA	Many
Ping	IT infrastructure
PI System Health	IT infrastructure
Siemens SIMATIC PCS 7	Many
UFL	Many
Wonderware Historian	Many

 Demo in presentation  
▶ Demo in Product Expo

# PI Connectors in development

PI Connector	Market	Status
▶ PI System Connector	All	Beta
▶ Redfish	Datacenter	Beta
◆ ▶ Modbus for Cisco IOx	All	Limited release soon
▶ IEC 61850	T&D	Beta
▶ GE Fanuc Focas	Discrete	Beta
▶ Siemens Sinumerik	Discrete	Beta
▶ MTConnect	Discrete	Beta
▶ MQTT Sparkplug	All	Alpha



Demo

- ◆ See also: **“Pervasive Data Collection for Industry 4.0”** Christian Leroux and Chris Felts, Thursday 15:25, Arora 17



# PI Connector for IEC 61850



# What is IEC 61850 for?



- Substation in Power Transmission and Distribution
  - IEDs: Intelligent Electronic Devices – like transformers, breakers and switches
  - Voltage, current, breaker positions, etc.
- Also supports IEC 61400-25 for wind energy generation

# IEC 61850 Protocol

The screenshot displays the OSIsoft IEC 61850 protocol configuration interface. The left sidebar shows a tree structure under 'DataSets' and 'Data Model'. The main 'Elements' pane shows a hierarchy: 'IEC61850 Connector' -> 'BayControllerQ' -> 'BayControllerQ' -> a list of elements including QA1CULO1, QA1CSWI6, QA1XCBR1, QB1CULO1, QB1CSWI1, QB1XSWI1, QC1CULO5, QC1CSWI5, QC1XSWI5, and T1MMXU1. A red box highlights this list of elements. The right pane shows a table of excluded attributes with columns for Name and a status icon.

**DataSets**

- rollerQ
  - LLN0.INTERLOCK
  - LLN0.MEAS
  - LLN0.STAT

**Data Model**

- rollerQ
  - LLN0
  - LPHD1
  - QA1CULO1
  - QA1CSWI6
  - QA1XCBR1
  - QB1CULO1
  - QB1CSWI1
  - QB1XSWI1
  - QC1CULO5
  - QC1CSWI5
  - QC1XSWI5
  - T1MMXU1

**Elements**

- IEC61850 Connector
  - BayControllerQ
    - BayControllerQ
      - QA1CULO1
      - QA1CSWI6
      - QA1XCBR1
      - QB1CULO1
      - QB1CSWI1
      - QB1XSWI1
      - QC1CULO5
      - QC1CSWI5
      - QC1XSWI5
      - T1MMXU1
      - A
      - PhV

**Excluded attributes are hidden.**

Filter	
Name	
phsA.cVal.mag.f	
phsA.q	
phsB.cVal.mag.f	
phsB.q	
phsC.cVal.mag.f	
phsC.q	

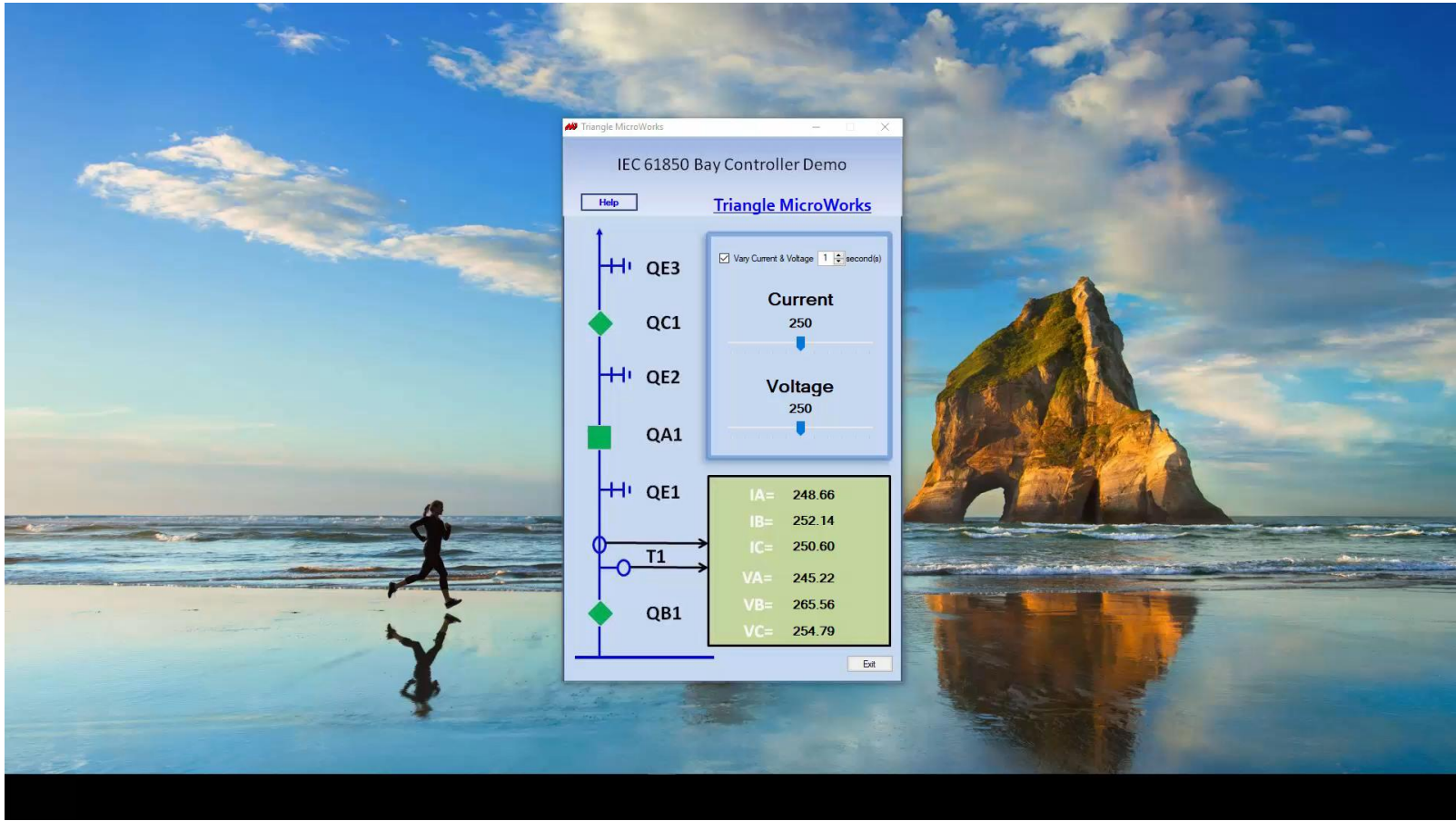

# PI Connector for IEC 61850 roadmap

- In final beta testing now
- Attending North American interop in October 2017
- Release 4Q 2017

# PI Connector – generations

PI Connector

PI Connector Relay

Administration

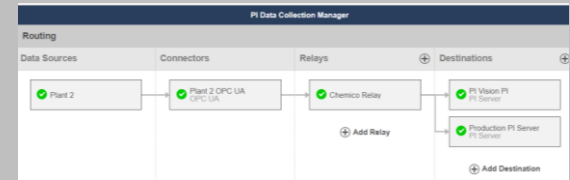
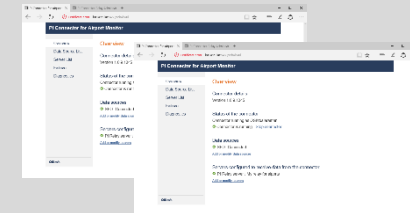
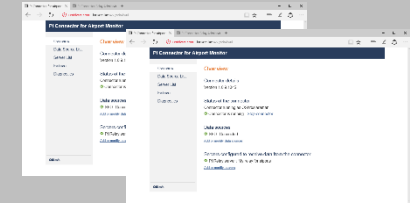
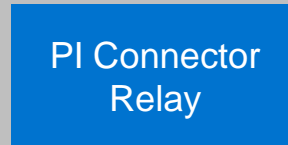
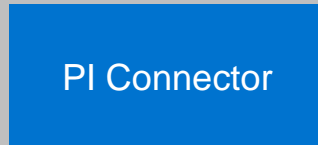
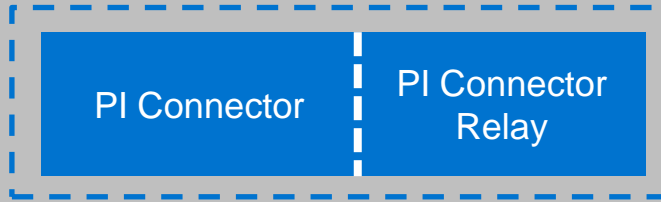

# ChemiCo

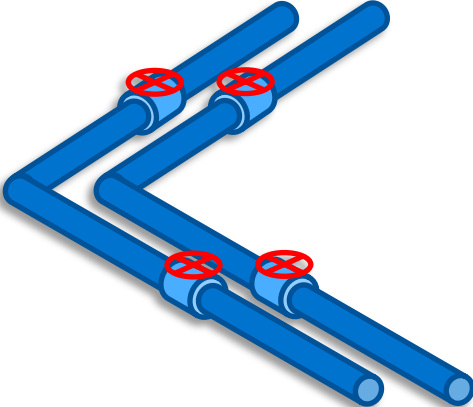

Pipeline

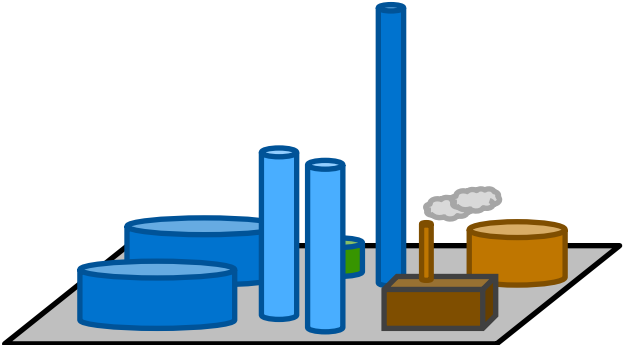

Feedstock plant

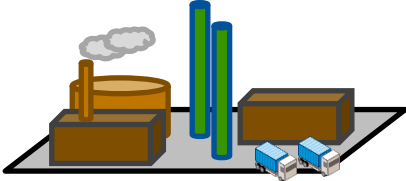

Chem 1

# New plant added

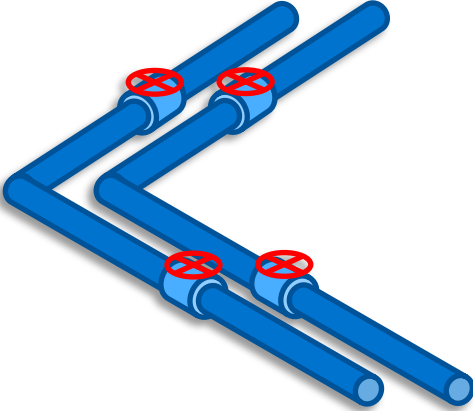

Pipeline

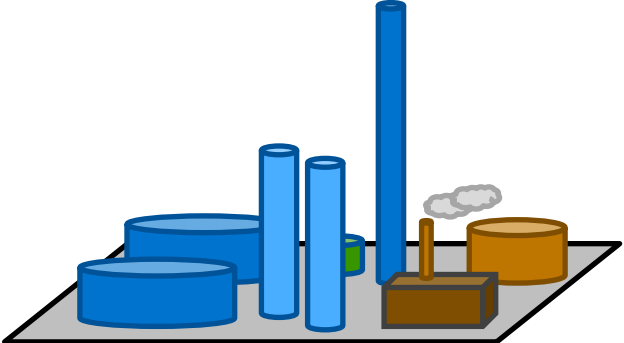

Feedstock plant

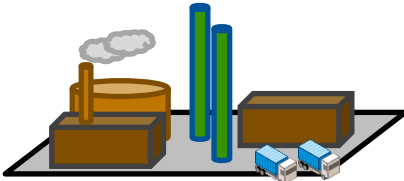

Chem 1

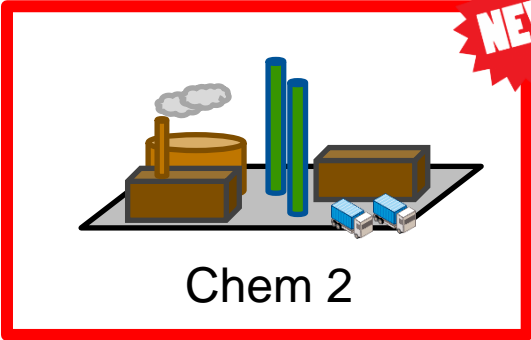

Chem 2

# Auto discovery and rule-based data selection

NEW



- Chemical Plant
  - Line 1
    - Heat Exchangers
      - Heat Exchanger 1001
        - Area
          - Cold Side Inlet Temperature
          - Cold Side Outlet Temperature
          - Hot Side Inlet Temperature
          - Hot Side Outlet Temperature
          - Manufacturer
        - Heat Exchanger 1002
      - Pumps
        - SF Pump 001
        - SF Pump 002
      - Tanks
    - Line 2



Easy



Select by rules:

Every Pump – 2 of 5 tags

Every Tank – all data

Every Heat Exchanger –  
only \*Temperature values



Automatic



Collect the data you need

Build the tags & reference AF  
model with meta data you select

Updates – Auto or with Approval



# Pipeline uses external network with limited bandwidth

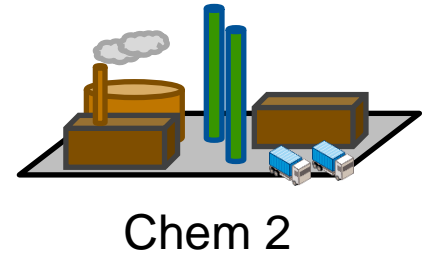
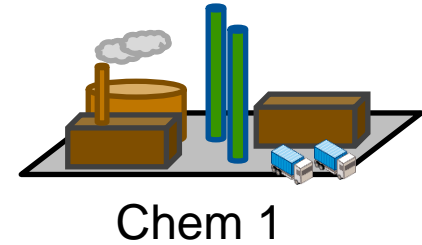
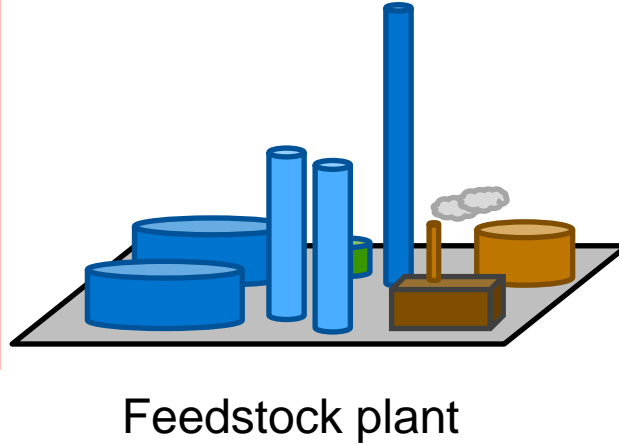
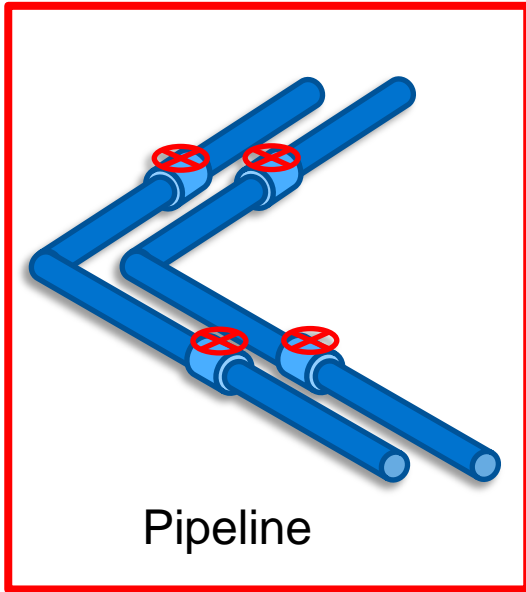

# Challenges across networks

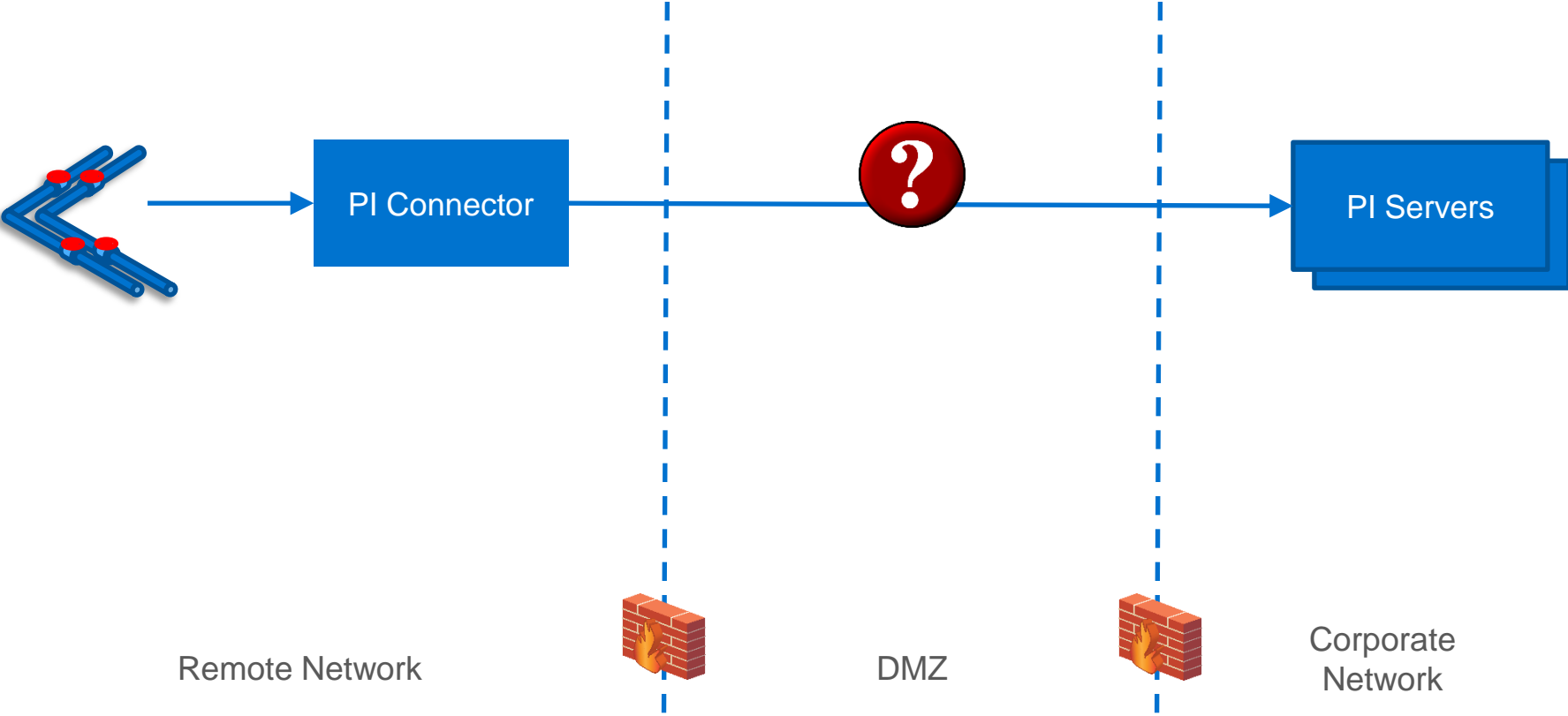

# Security for remote networks

Secure and Flexible

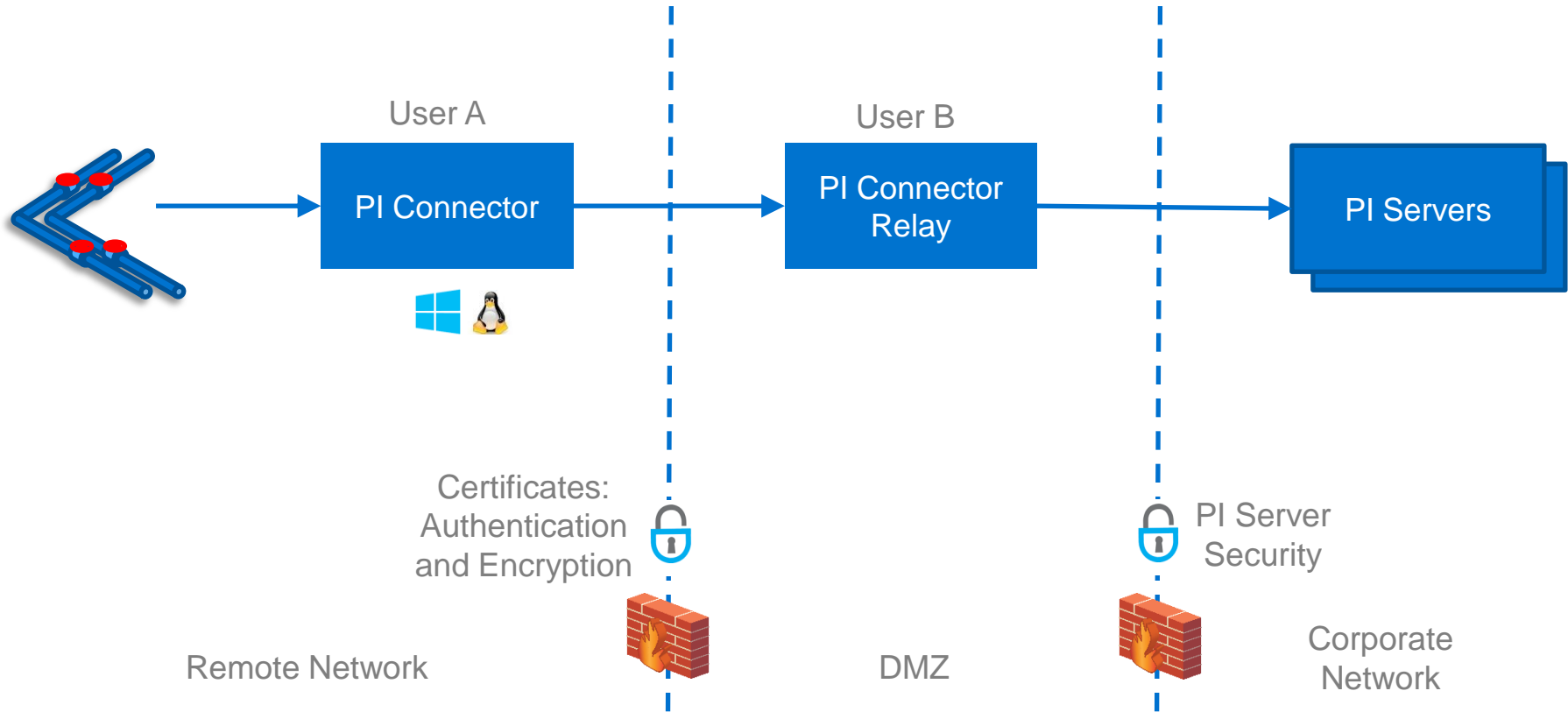

# Compress data to limit bandwidth

Secure and Flexible

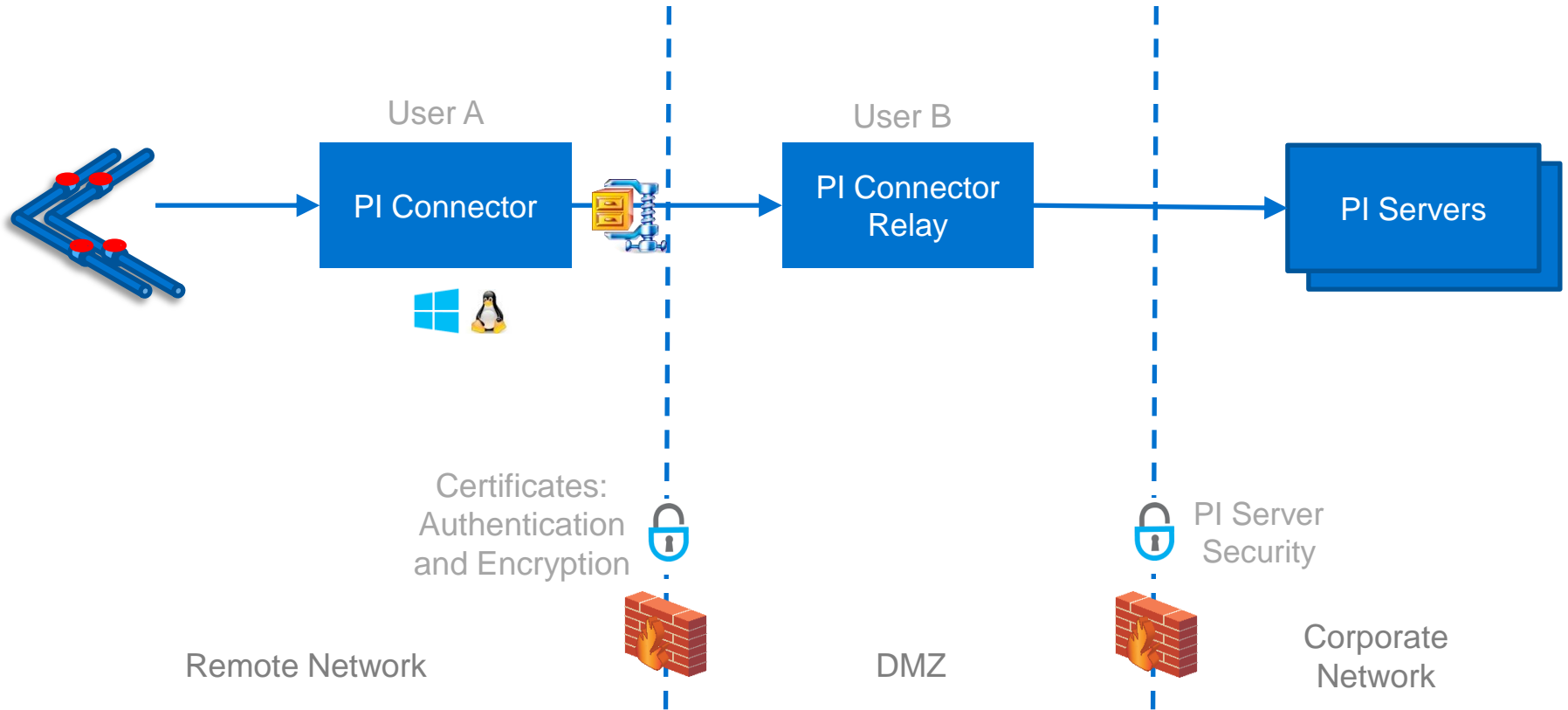

# Flexible and secure routing

Secure and Flexible

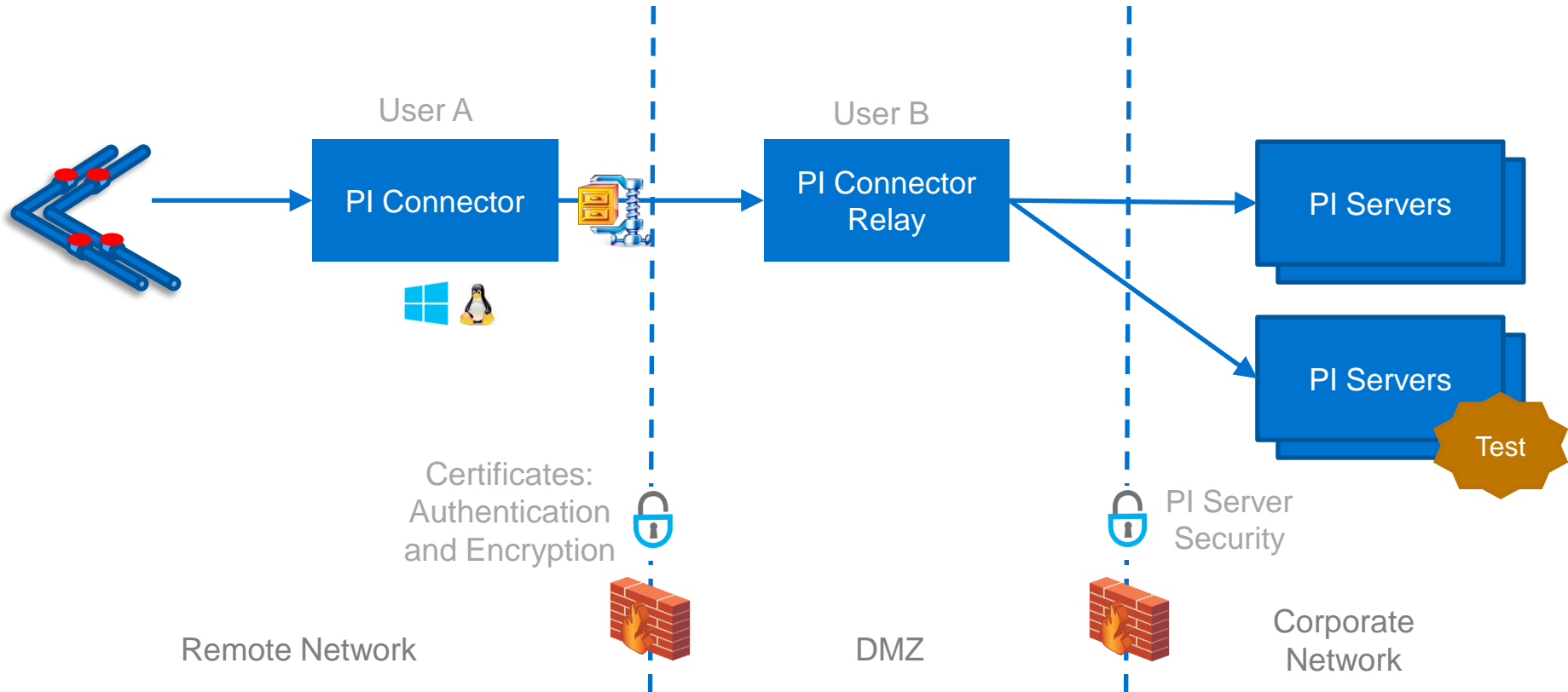

Remote Network

DMZ

Corporate Network

# Flexible and secure routing

Secure and Flexible 

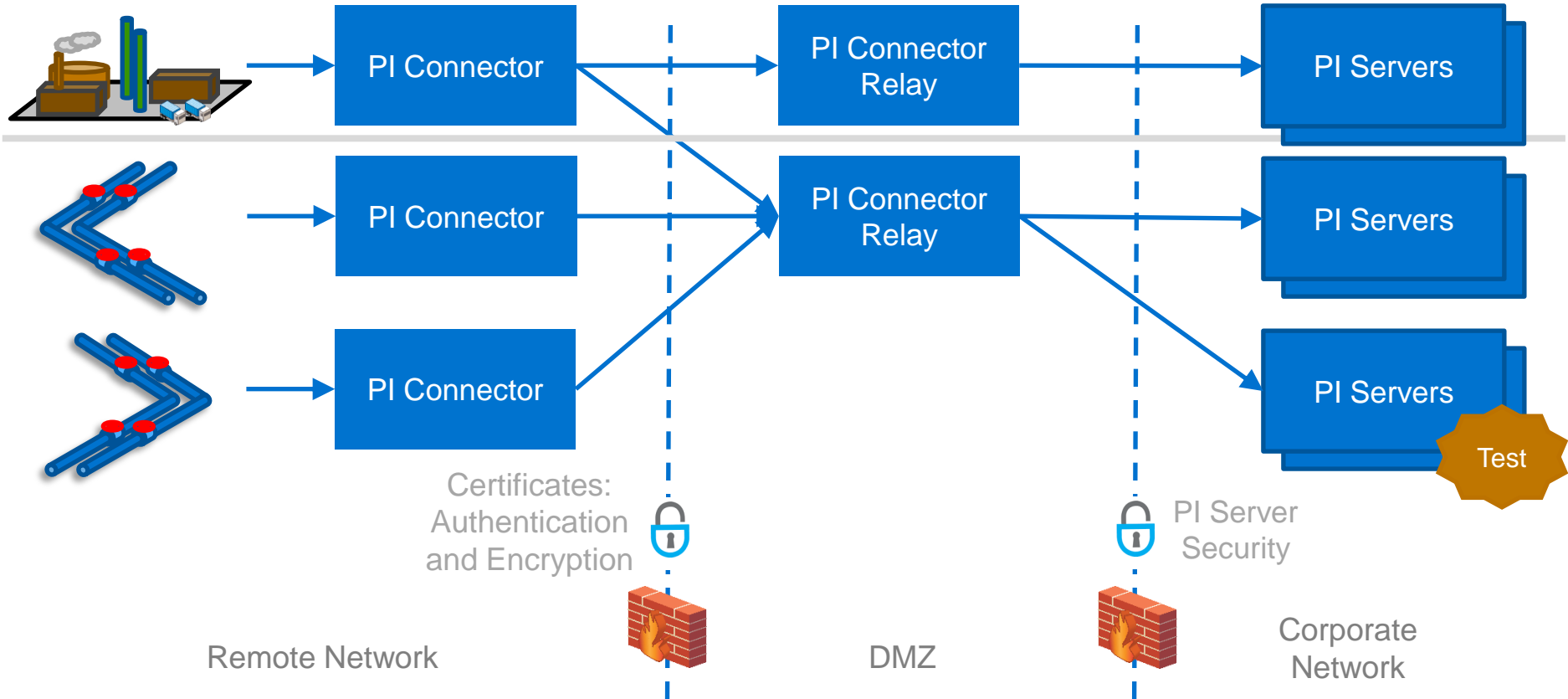

# How do you configure and manage your data flow?

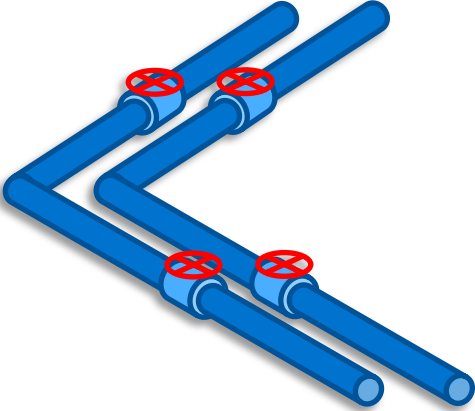

Pipeline

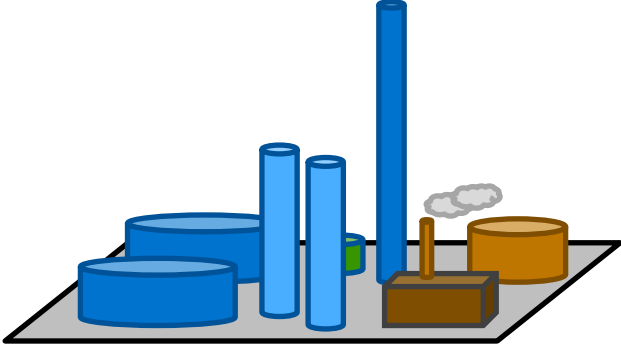

Feedstock plant

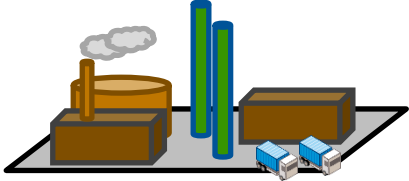

Chem 1

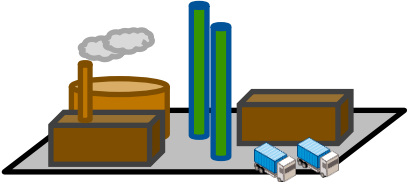

Chem 2

# PI Connector Administration

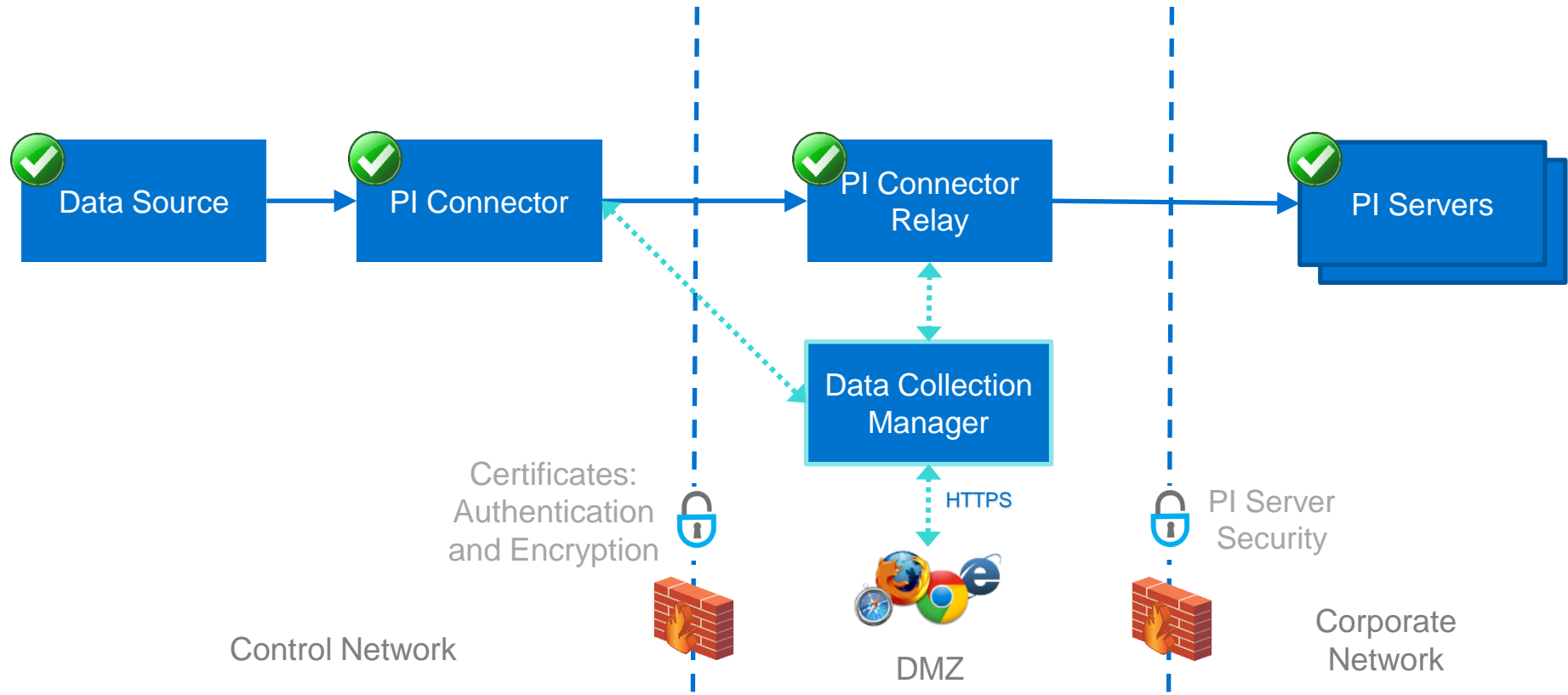



# PI Connector Administration

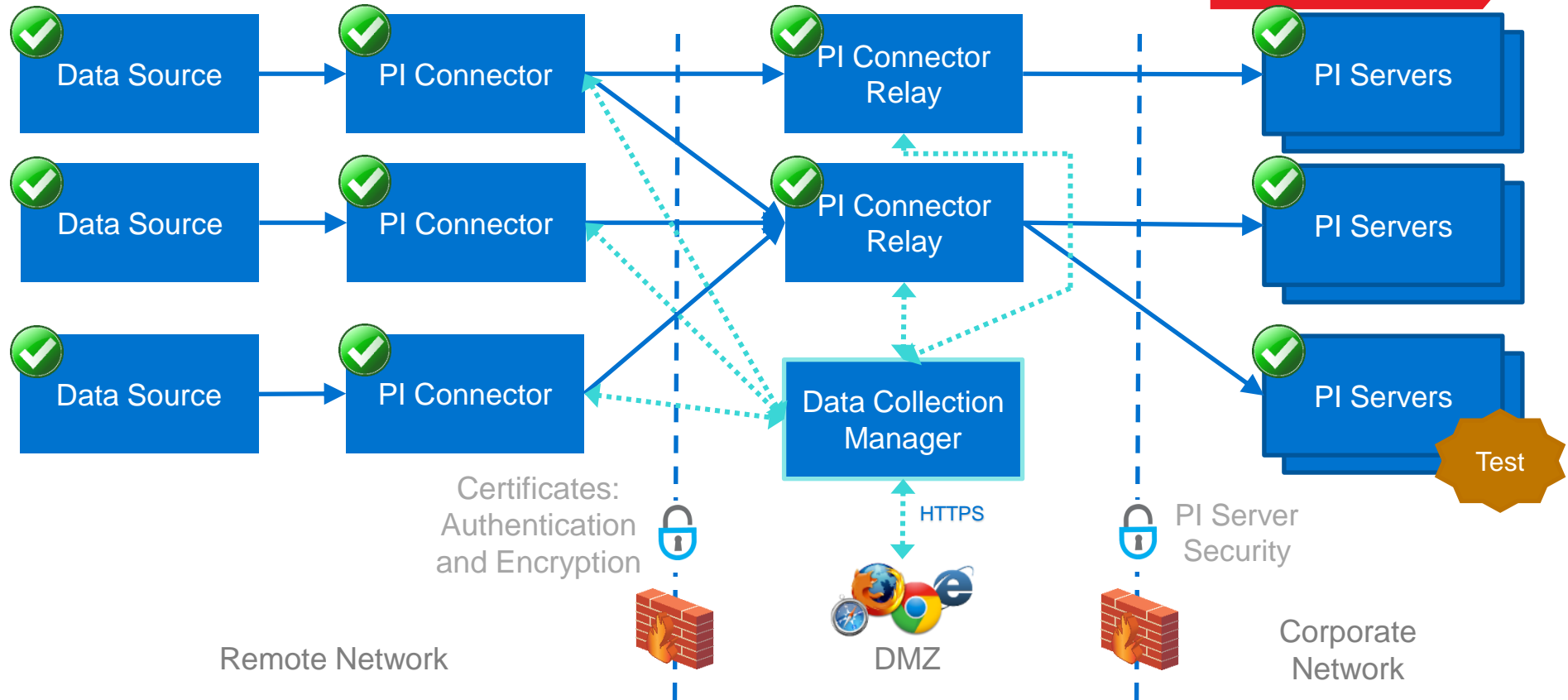



# PI Connector for OPC UA

# Example of a modern data source – OPC UA

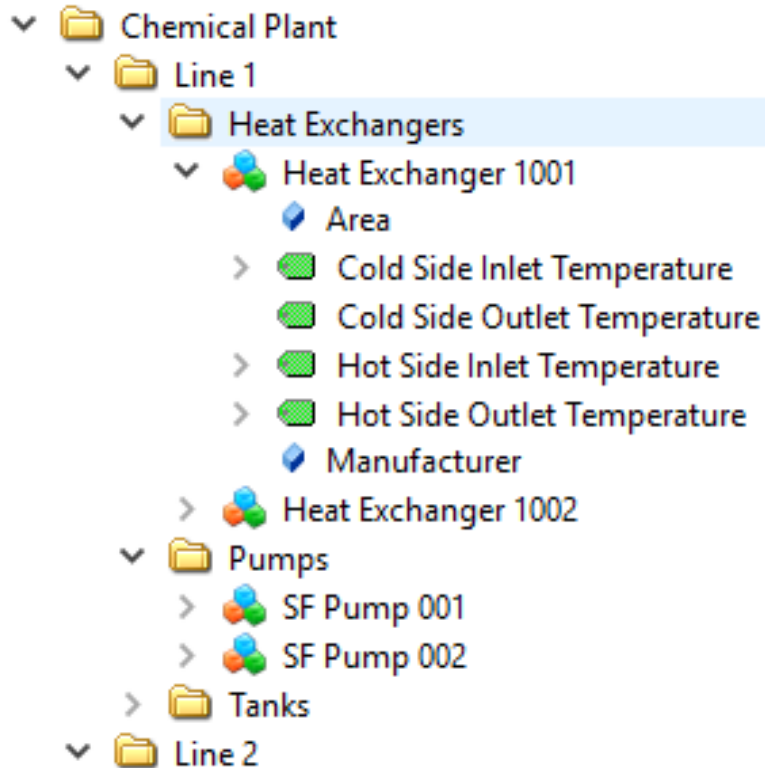

- Information model – meta data
- Typed meta data – templates
- Data by exception
- Discoverable
- Supports:
  - Data Access (DA)
  - Historical Access (HA)
  - Alarms and Conditions (A&C)

# PI Connector for OPC UA – Released version

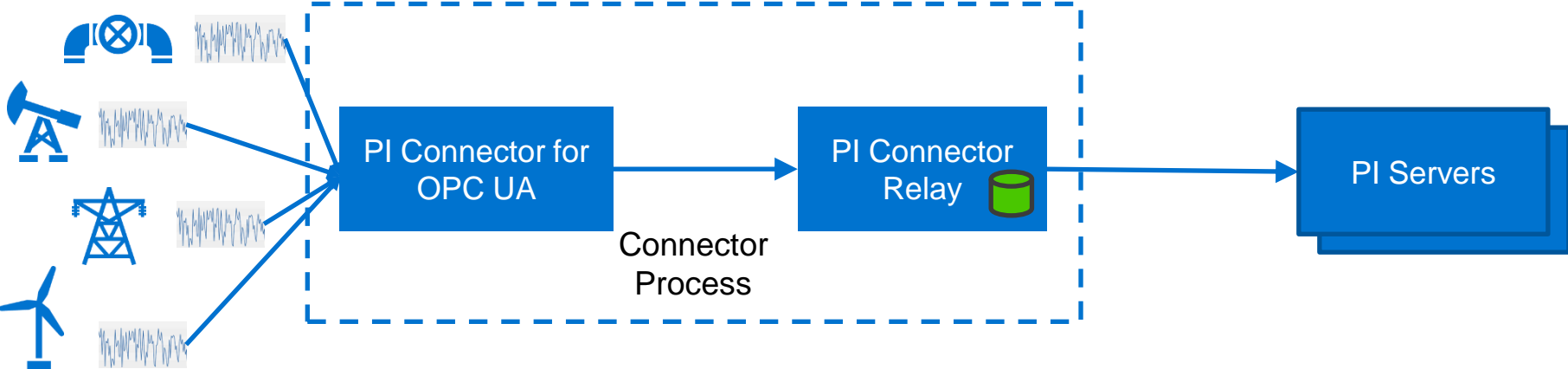

# PI Connector for OPC UA – Upcoming version

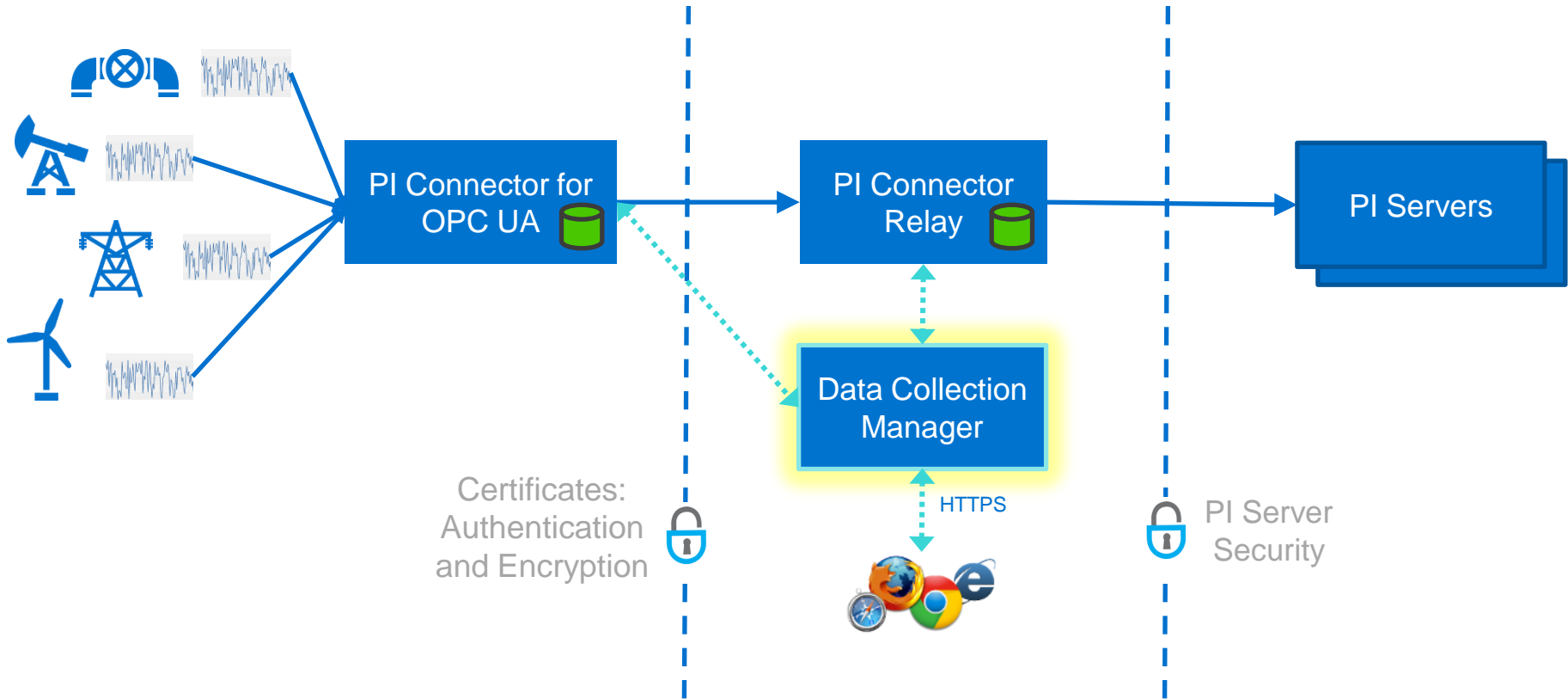

# Demo

The screenshot displays the PI Data Collection Manager web application. The browser address bar shows the URL `https://taudemo:5500/ui/dda/config`. The application title is "PI Data Collection Manager".

The interface is divided into three main sections:

- Components:** A sidebar on the left with a menu icon and a list of expandable items: Data Sources, Connectors, Relays, and Destinations.
- Routing:** The central area contains a table with four columns: Data Sources, Connectors, Relays, and Destinations. Each of the last three columns has a plus sign icon in its header. The table is currently empty.
- Overview:** A right-hand pane containing introductory text:
  - "Use this application to set up, maintain, and manage your PI Connector data flow."
  - "The Components list shows the data sources, connectors, relays, and destinations set up in your data flow."
  - "The Routing area shows how the Components are connected to each other to get data from data sources to destinations."
  - "This pane shows contextual information about the items you select. To clear your selection and see this overview, click in any open area."A "Less" link is visible at the bottom of the overview pane.

At the bottom right of the Routing table, there is a link labeled "Edit Routing Configuration" with a pencil icon.

# When can I get it?

- Beta in 3Q-4Q
  - PI Connectors for GE Fanuc Focas, Siemens Sinumerik and MTConnect
  - PI Connector for Redfish
  - with PI Connector Relay and Data Collection Manager
  - Interested? Contact us [betaconnectors@osisoft.com](mailto:betaconnectors@osisoft.com)
- Release in 4Q
- Come and play with it live at the product expo!



# PI Connector for UFL



# PI Connector for UFL Architecture

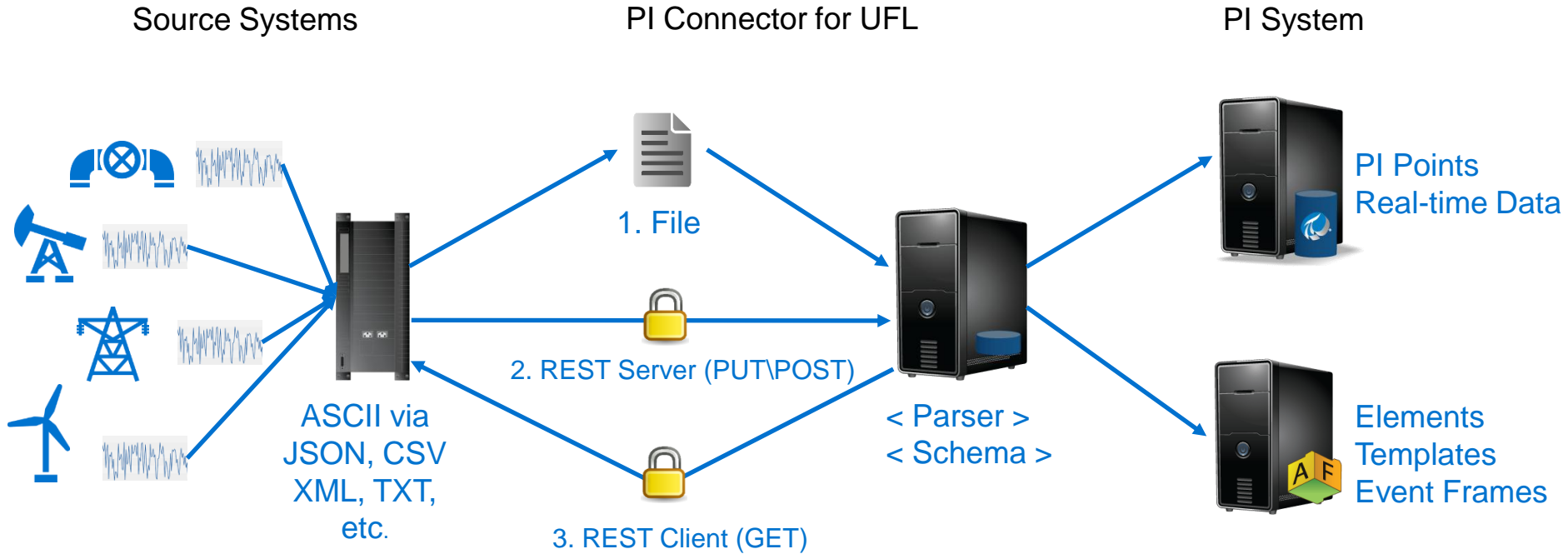

# PI Connector for UFL – Version 1.2 update

- Version 1.2 in beta now. Release 4Q
  - Native JSON parsing support
  - ForEach construct
  - Call external URL with multiple parameters (REST Client channel)
  - Performance enhancements

# Example – Railway web service

Approx. 2600 UK railway stations in JSON format

```
''  
{  
  "code": "9100SUTCO",  
  "name": "Sutton Coldfield Rail Station",  
  "lat": 52.56494,  
  "lon": -1.82484  
},  
{  
  "code": "9100SUTTON",  
  "name": "Sutton (London) Rail Station",  
  "lat": 51.35953,  
  "lon": -0.19121  
},  
{  
  "code": "9100SUTTONC",  
  "name": "Sutton Common Rail Station",  
  "lat": 51.37489,  
  "lon": -0.19634  
},  
}
```

UFL parsing logic

```
16  ForEach(JsonGetItem(__MESSAGE, "[")) DO  
17  
18      StatAttributes = Add("Name", JsonGetValue(__ITEM, "name"))  
19      Value_Number = JsonGetValue(__ITEM, "lon")  
20      StatAttributes = Add("Lon", Value_Number)  
21      Value_Number = JsonGetValue(__ITEM, "lat")  
22      StatAttributes = Add("Lat", Value_Number)  
23      StatAttributes = Add("Code", JsonGetValue(__ITEM, "code"))  
24  
25      StoreElement("UK_RailWayStations")  
26      Value_String = JsonGetValue(__ITEM, "code")  
27      StoreElement("UK_RailWayStations" + CHAR(92) + Value_String, "RailWayStatio  
28  
29      StatAttributes = Clear()  
30  ENDFOR
```

# UK Railway stations



● Railway station

# PI System Connector

# PI System Connector aggregates data from sites to corporate

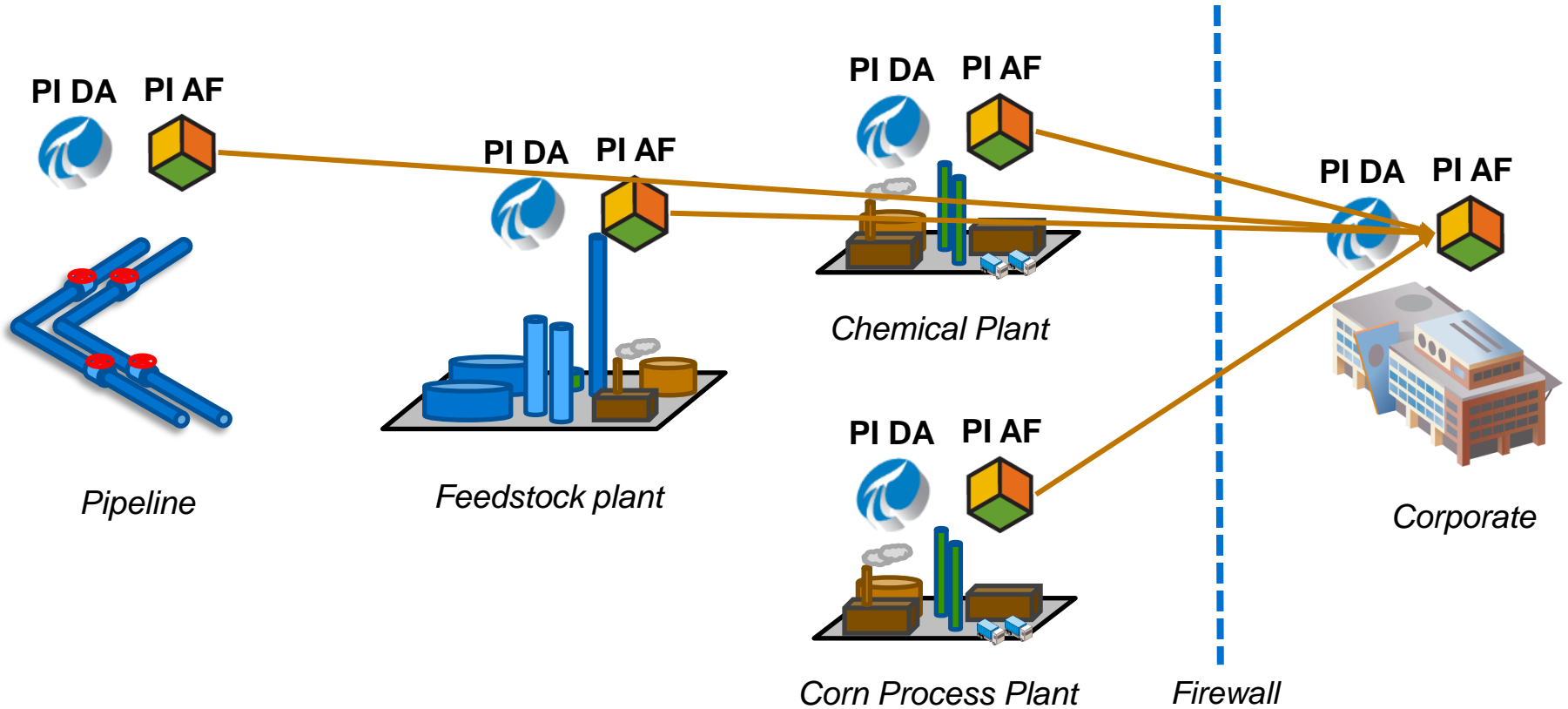

# PI System Connector Architecture

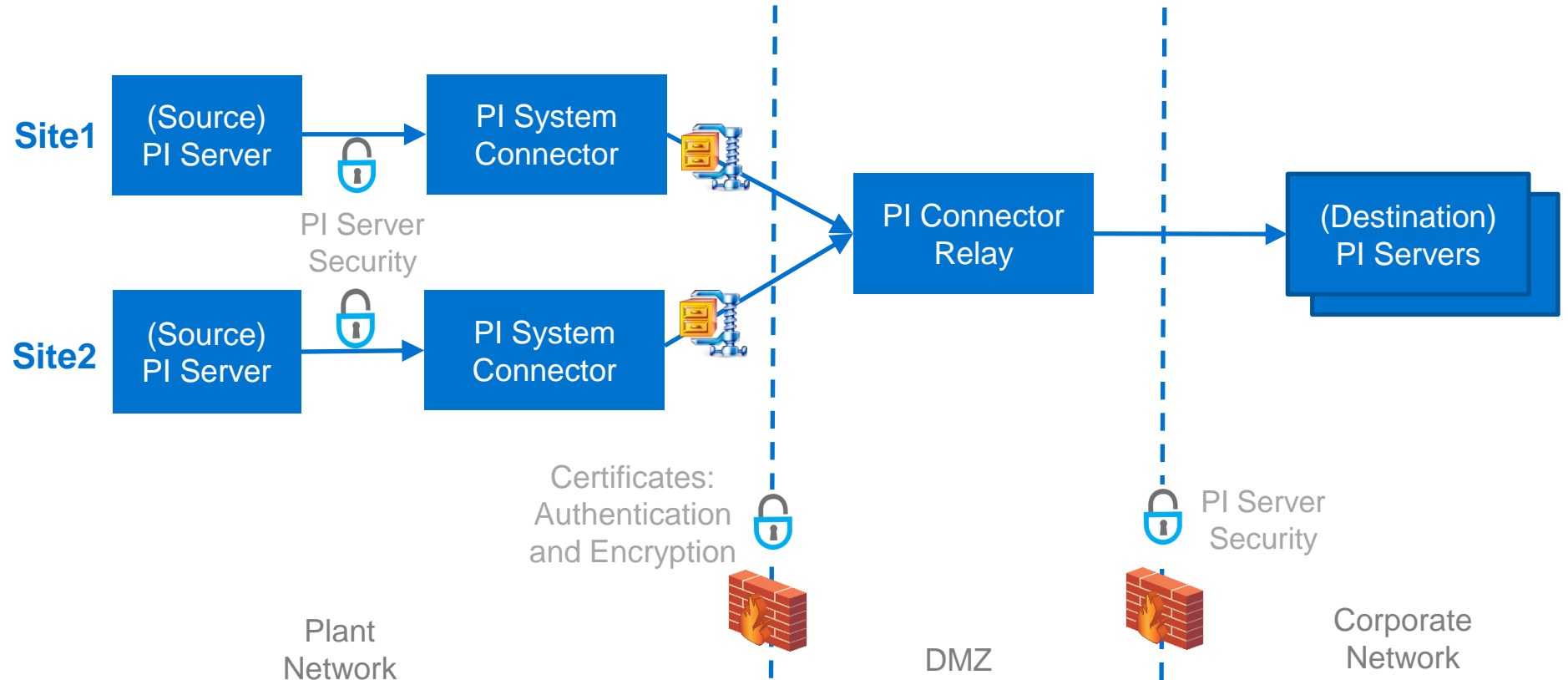

# What data is PI System Connector moving?

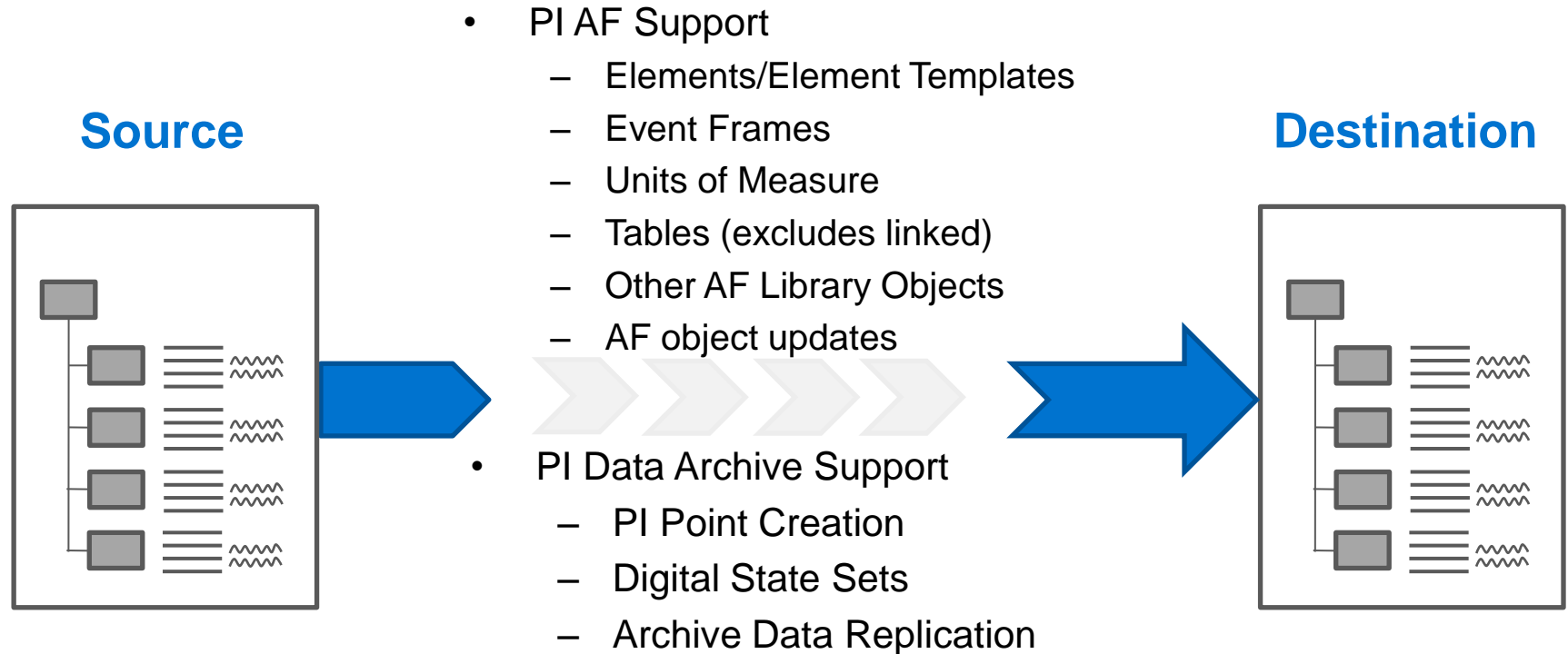



# PI System Connector roadmap

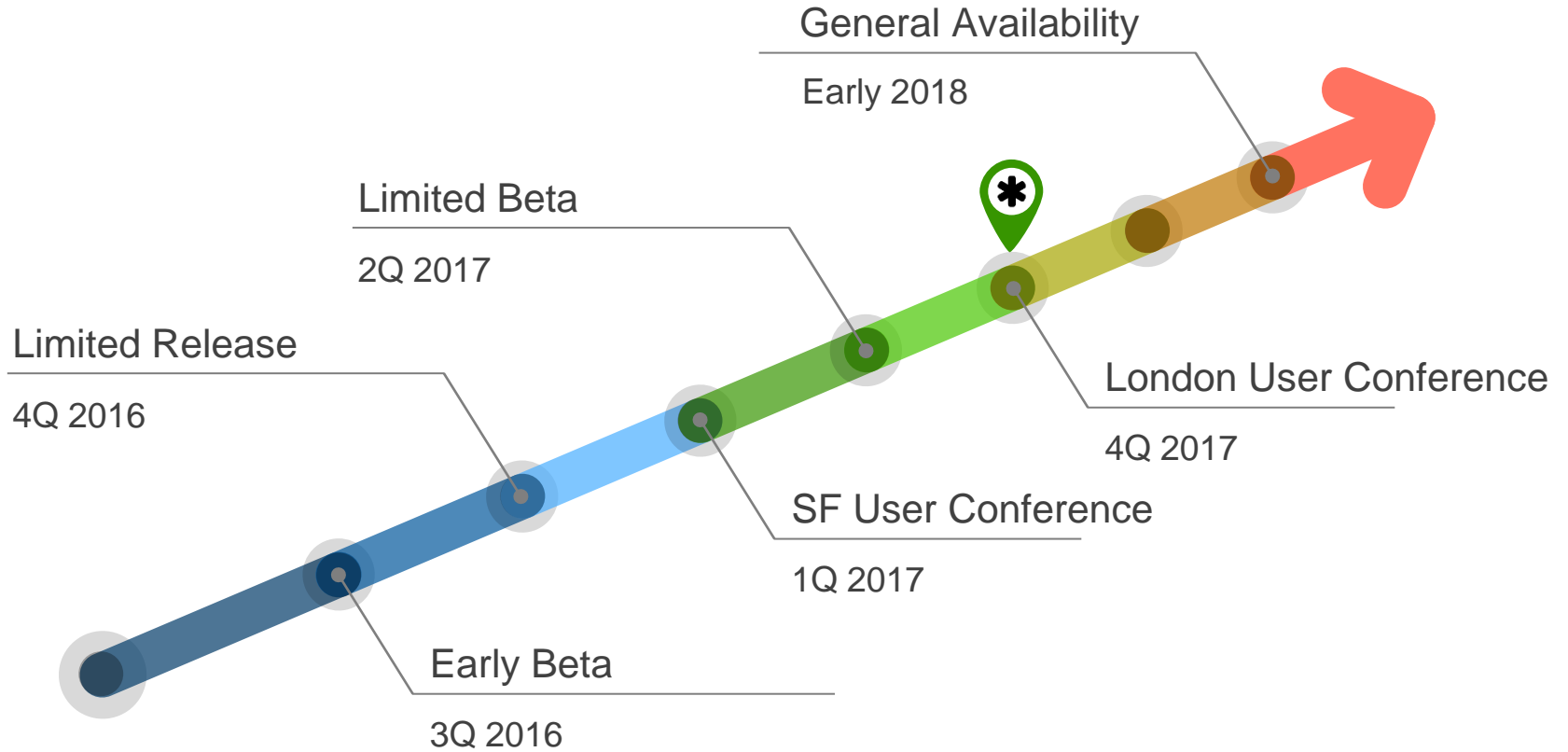



# Asset Transformation

# PI Connector creates reference model

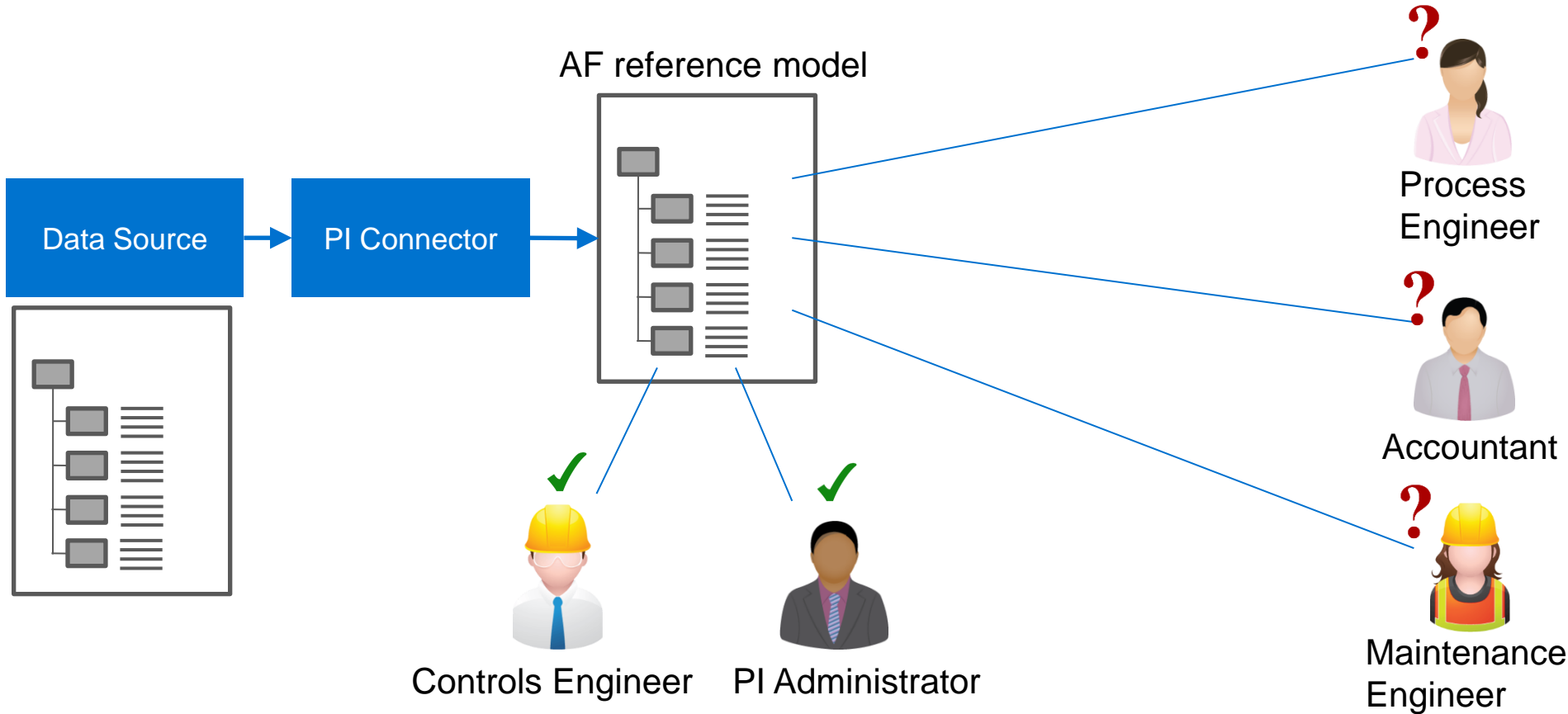

# Transformations create business models

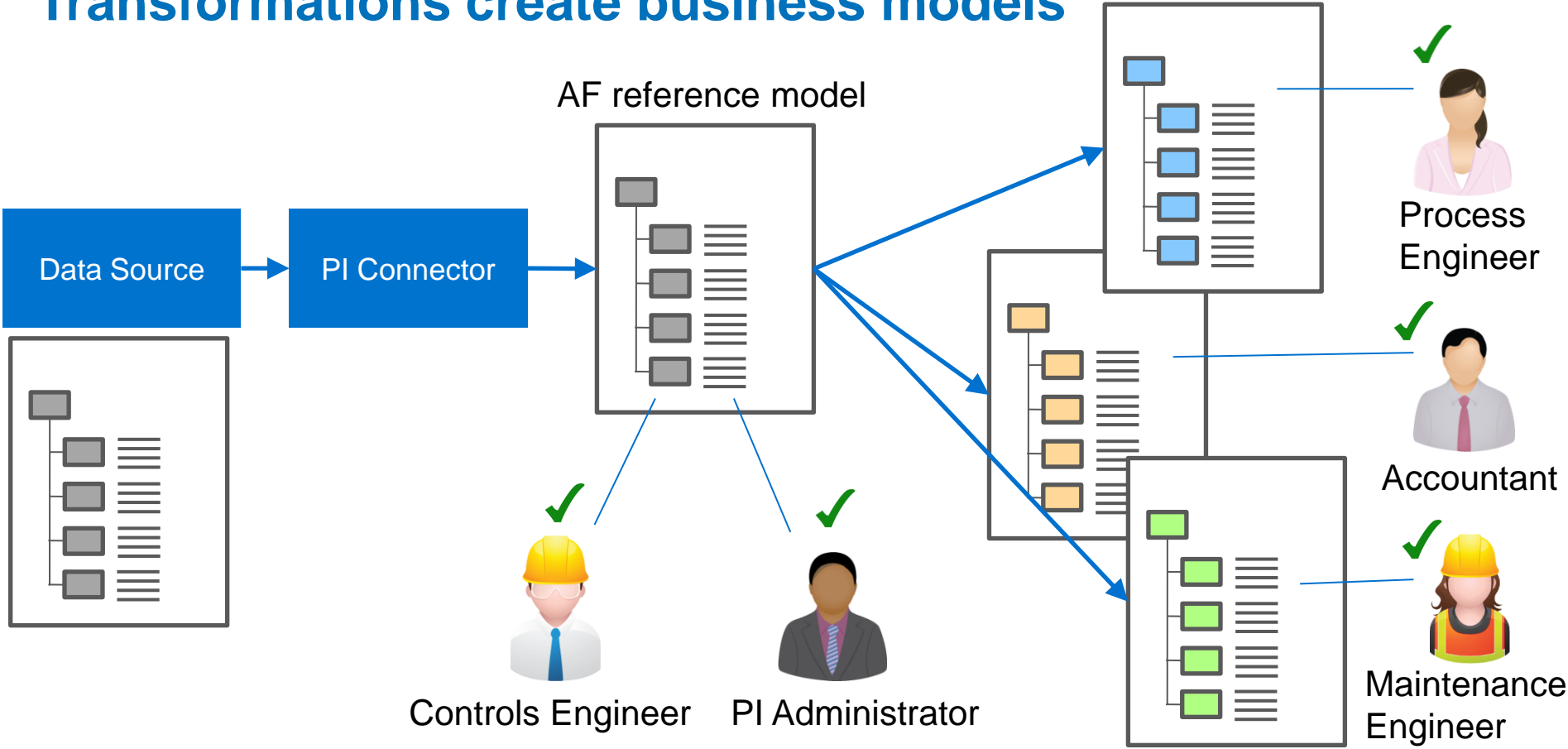

# Transformations create business models

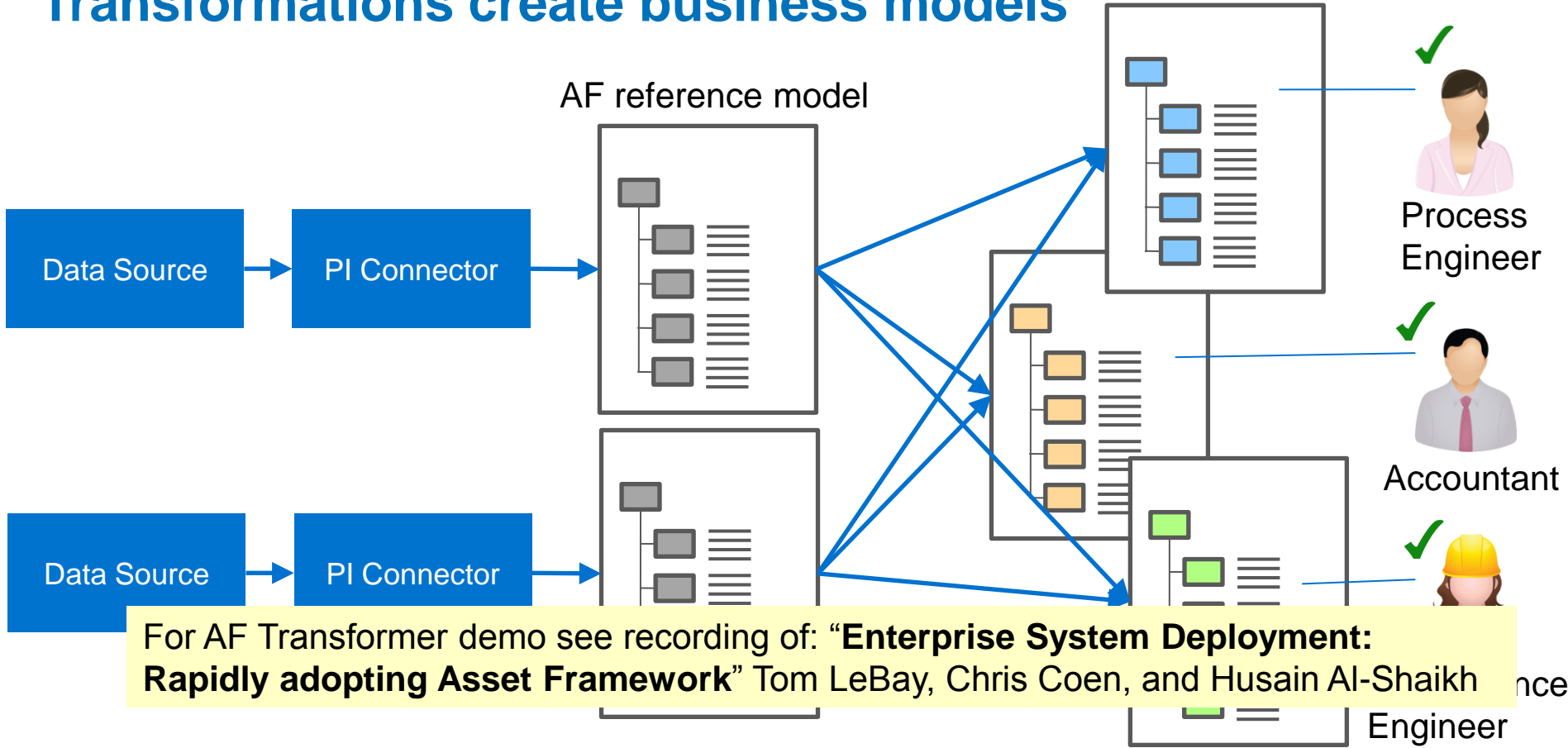

# PI Connectors can make you more strategic

- Beta in 3Q-4Q 2017, release 4Q 2017
  - PI Connector Relay
  - Data Collection Manager
  - PI Connector for GE Fanuc Focas, Siemens Sinumerik, MTConnect, and Redfish
- PI System Connector in beta
- AF Transformer – beta testing
- Come see us in the Product Expo – at the PI System Connectivity booth!

Easy



Automatic



Unified



Secure and Flexible



# Contact Information

**Chris Coen**

[ccoen@osisoft.com](mailto:ccoen@osisoft.com)

Product Manager



**Zdenek Ryska**

[zryska@osisoft.com](mailto:zryska@osisoft.com)

Senior Software Developer



## Questions

Please wait for the **microphone** before asking your questions



State your **name & company**

## Please remember to...

Complete the Online Survey for this session

Download the Conference App for OSISOFT USERS CONFERENCE 2017



- View the latest agenda and create your own
- Meet and connect with other attendees



HTML

search OSISOFT in the app store

<http://bit.ly/uc2017-app>



감사합니다

谢谢

Danke

Merci

Gracias

**Thank You**

ありがとう

Спасибо

Obrigado

# Backup slides

# Older data sources

Register	Value
1	27
2	Off
3	53.89
4	3.2
...	...
2501	Running
2502	45.8
2503	1

Older data sources:

- Data by polling
- Names of source sometimes just a number
- Not always discoverable
- Modbus even more limited

PI Interfaces work great for these

- Continued development adopting new security options announced in 2016
- See Product Expo for details on PI Interfaces and the latest releases

# Moving data across network?

# - PI System Connector

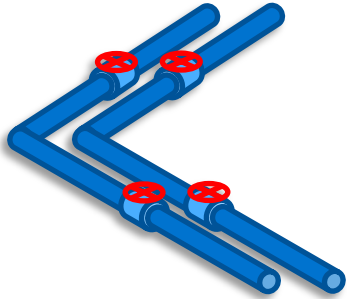

Pipeline

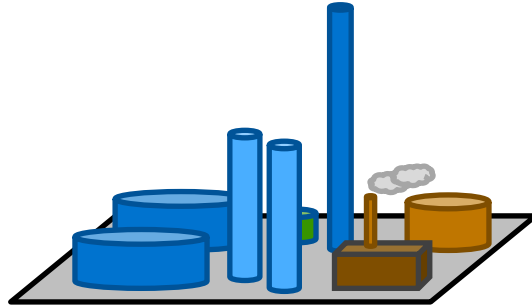

Feedstock plant

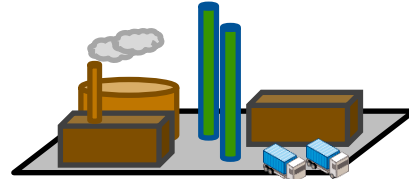

Chemical Plant

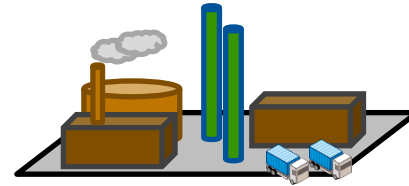

Corn Process Plant



Corporate



Easy



Easy



Automatic



Automatic



Unified



Unified



Secure and Flexible



Secure and Flexible

